

GROOVE10 BC/UX

RECESSED PROFILE / PROFIL WPUSTOWY

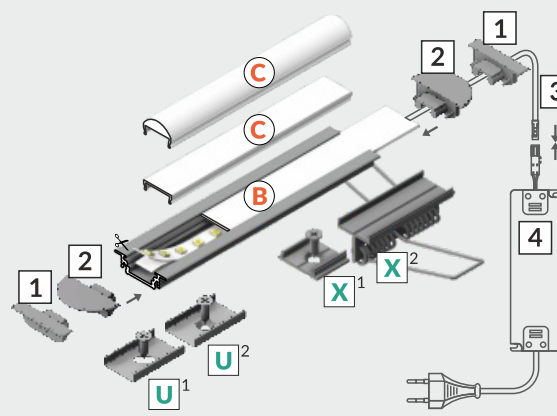
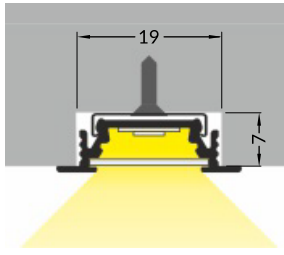
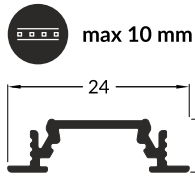

- B** B slide cover
klosz B wsuwany
- C** C click cover
klosz C klik
- C** C click cover lens
klosz C klik soczewka
- U¹** U flexible mounting plate
uchwyt U sprężysty
- U²** cone U flexible mounting plate
uchwyt U sprężysty cone
- X¹** X mounting plate
uchwyt X
- X²** spring X mounting plate
uchwyt X sprężyna

- 1** GROOVE10 ending gen2 SQ
zaślepka GROOVE10 gen2 SQ
- 2** GROOVE10 ending gen2
zaślepka GROOVE10 gen2

- 3** power supply cable
kabel zasilania
- 4** LED power supply
zasilacz LED

- scissors
nożyczki
- hacksaw
piłka
- pliers
kombinerki
- solder
cyna
- soldering iron
lutownica
- screwdriver
wkrętek
- glue
klej
- drill
wiertarka

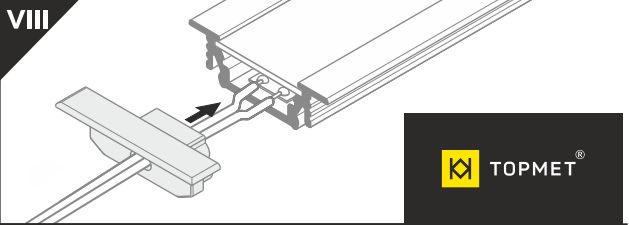
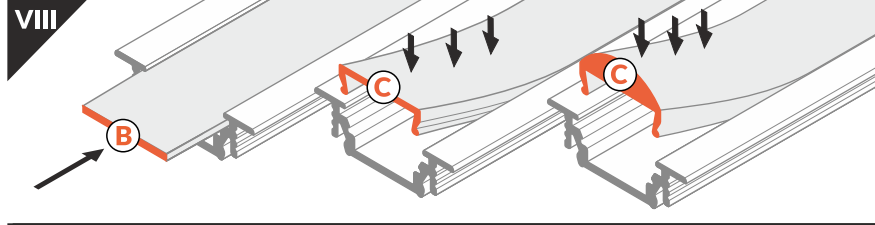
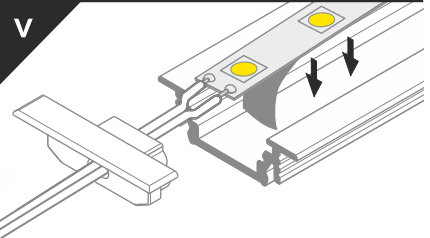
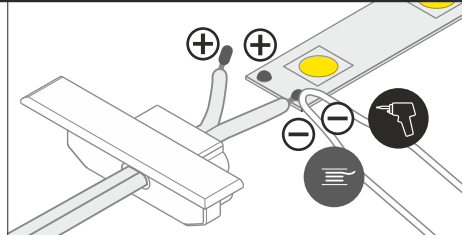
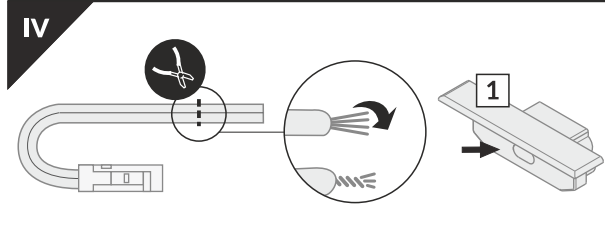
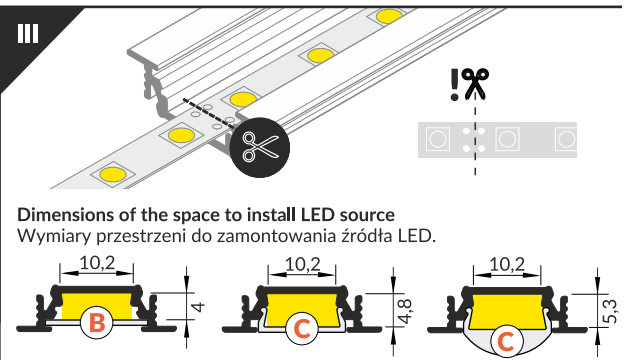
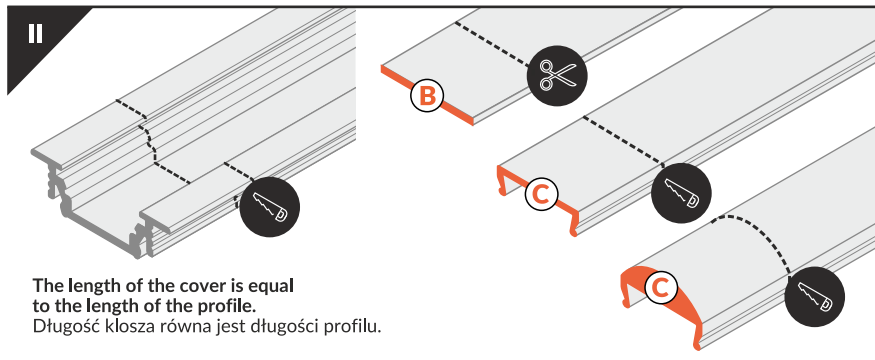
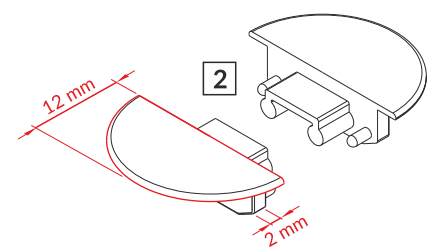
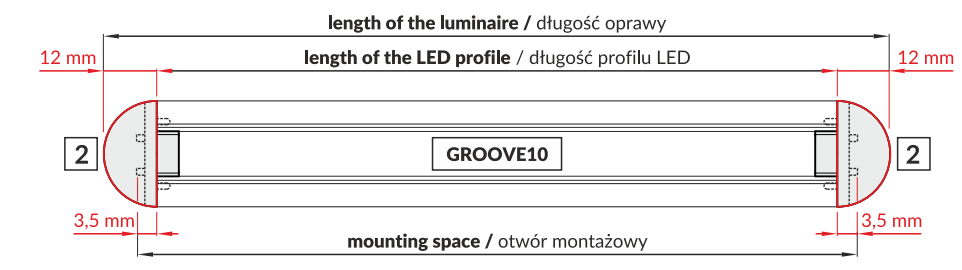
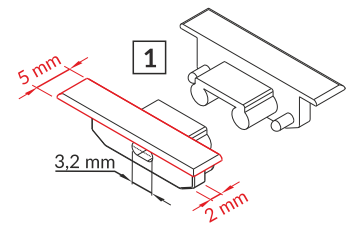
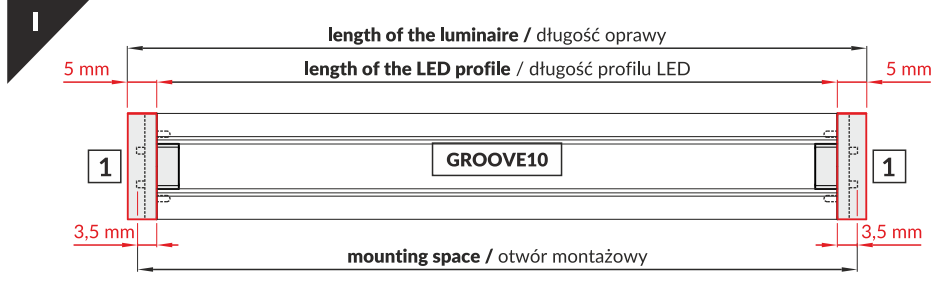

IX MOUNTING / MONTÁŽ

U flexible mounting plate
uchwyt U sprężysty

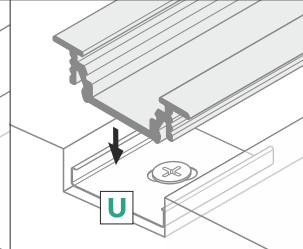
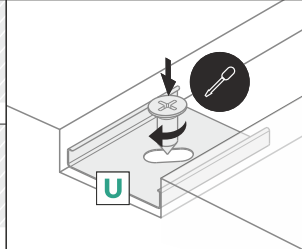
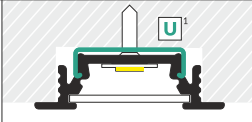

cone U flexible mounting plate
uchwyt U sprężysty cone

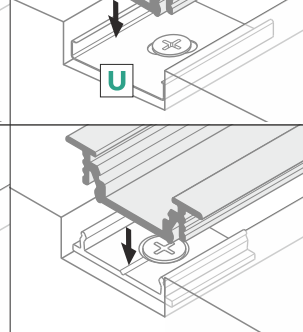
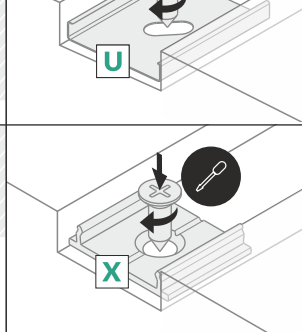
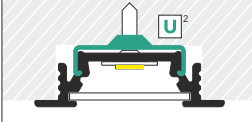

X mounting plate
uchwyt X

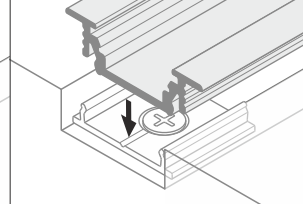
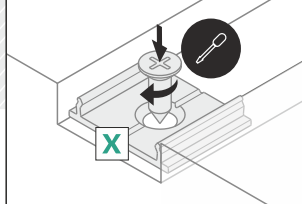
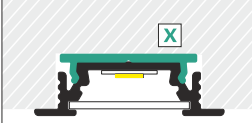

spring X mounting plate
uchwyt X sprężna

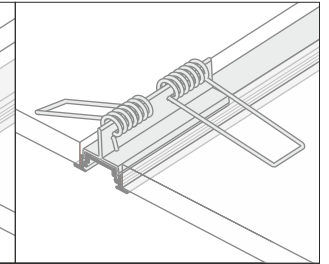
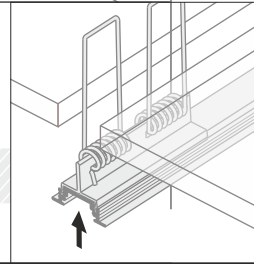
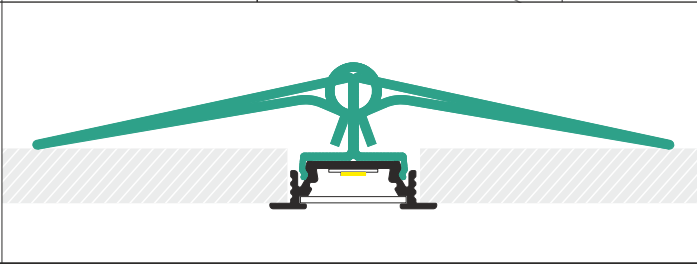

 Other mounting possibilities: with mounting glue or mounting tape, with screws
Pozostałe możliwości montażu: na klej lub taśmę montażową, na wkręty

IX CONNECTORS / ŁĄCZNIKI

X connector 180 deg / łącznik X 180 st

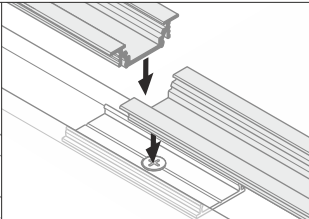
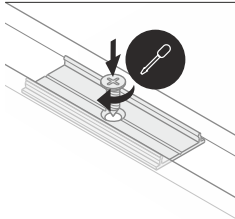

GROOVE10 connector 90 deg / łącznik GROOVE10 90 st

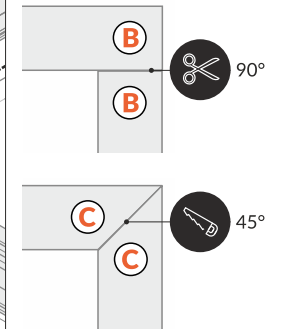
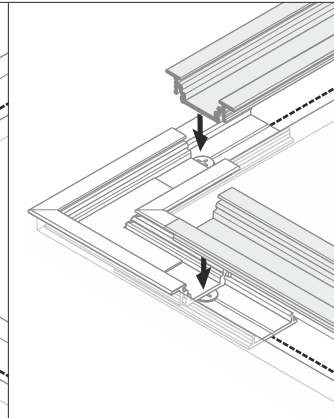
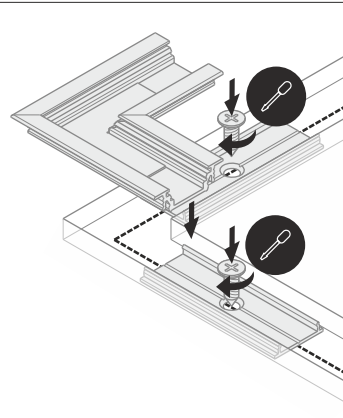

 X connector may be used to make extra long profiles by connecting multiple profiles.
Łącznik X może być użyty do stworzenia pojedynczego bardzo długiego profilu.

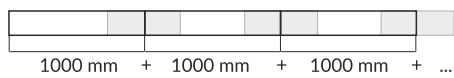

1000 mm + 1000 mm + 1000 mm + ...

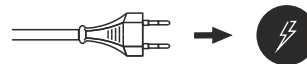
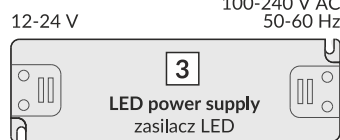
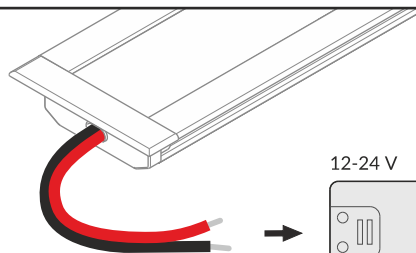

Hungarian distributor



www.s-lightled.hu | www.topmet.com

