

BEGTON12 J/S

SURFACE PROFILE PROFIL NAWIERZCHNIOWY

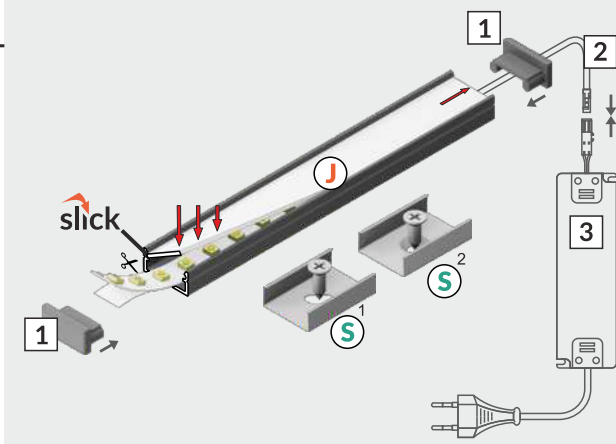

- J** J slide cover
klosz J wsuwany
- S**¹ S flexible mounting plate
uchwyt S sprężysty
- S**² cone S flexible mounting plate
uchwyt S sprężysty cone
- 1** BEGTON12 ending
zaślepka BEGTON12
- 2** power supply cable
kabel zasilania
- 3** LED power supply
zasilacz LED

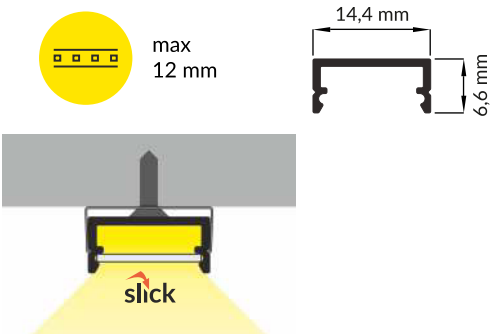

scissors
nożyczki



pliers
kombinerki



soldering iron
lutownica



solder
cyna



glue
klej

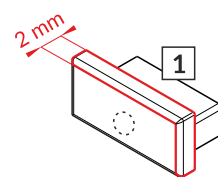
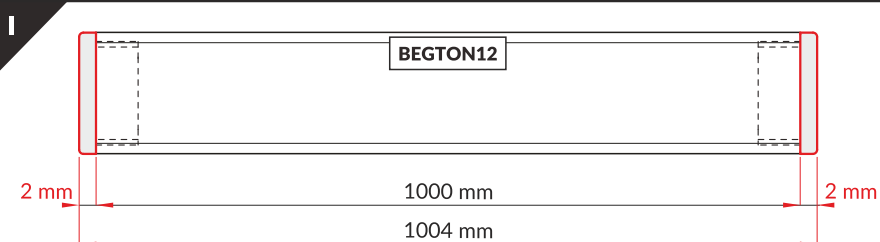

Note! Ending with marked space to bore the holes.
Uwaga! Zaślepka z punktami do przewiercenia otworów.

Note! Ending thickness increases the length of the luminaire (+ 2 x 2 mm).
Uwaga! Grubość zaślepki zwiększa długość oprawy (+ 2 x 2 mm).

II

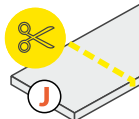

The length of the cover is equal to the length of the profile.
Długość klosza równa jest długości profilu.

III

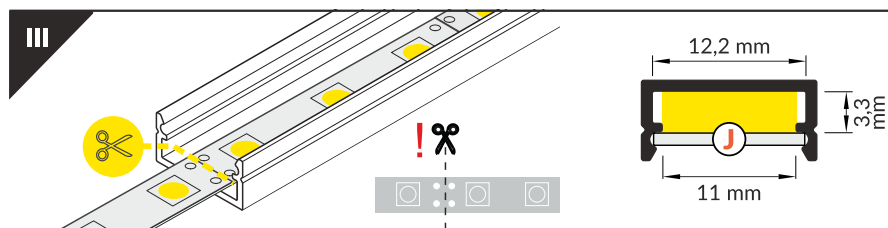

Dimensions of the space to install LED source.
Wymiary przestrzeni do zamontowania źródła LED.

IV

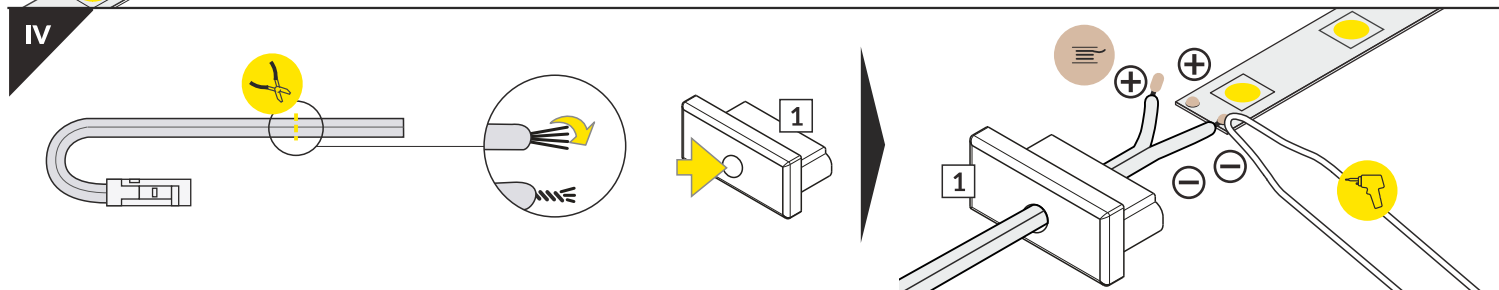

V

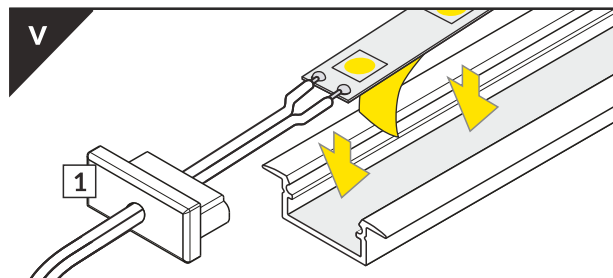

VI

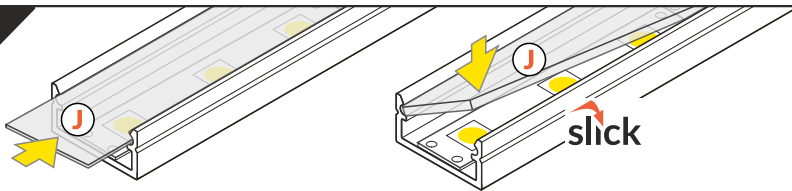

J slide cover / klosz J wsuwany

VII MOUNTING / MONTAŻ

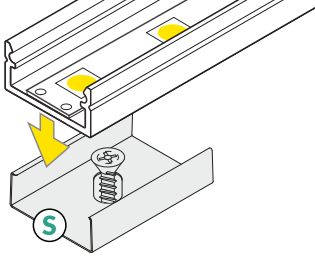

S flexible mounting plate
uchwyt S sprężysty

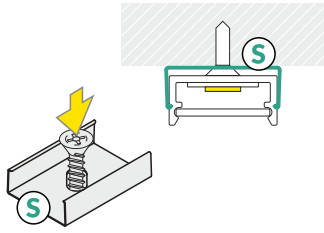

S flexible mounting plate
uchwyt S sprężysty

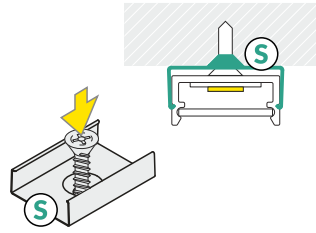

cone S flexible mounting plate
uchwyt S sprężysty cone

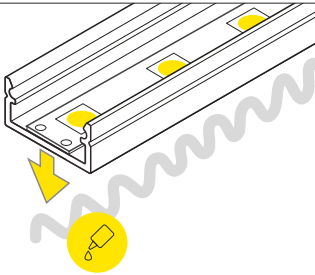

glue
klej montażowy

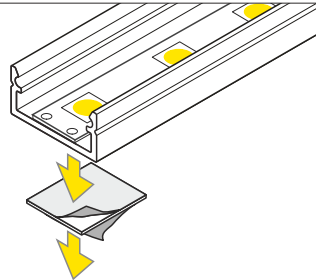

two-sided adhesive tape 25x25
taśma mocująca dwustronna 25x25

VIII

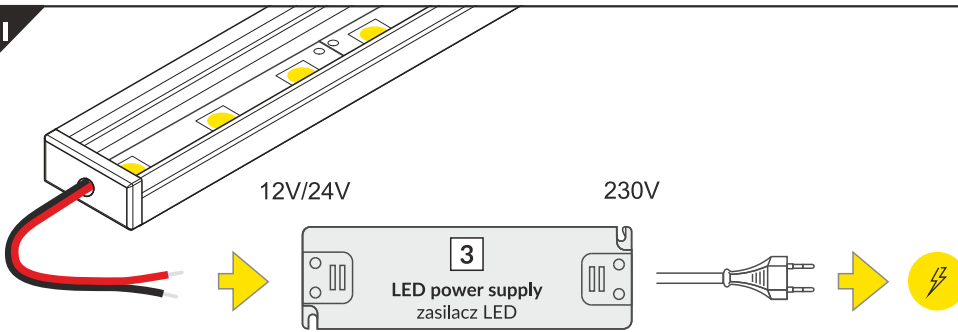

ACCESSORIES / AKCESORIA

- power switches
- controller + remote
- movement sensors

- włączniki
- sterownik + pilot
- czujniki ruchu