

QUARTER10 BD / U6

CORNER PROFILE / PROFIL KĄTOWY

max 10 mm

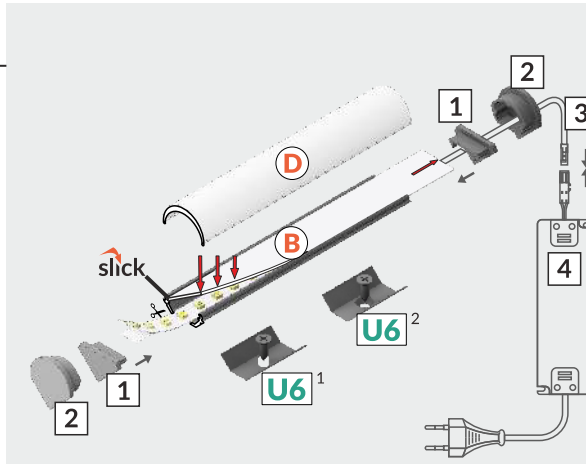
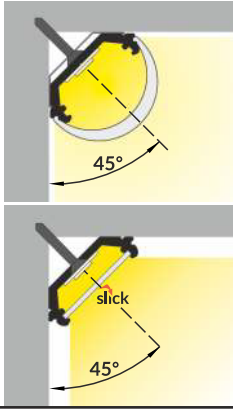
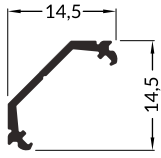

- B** B slide cover
klosz B wsuwany
- D** D click cover
klosz D klik
- U6**¹ U6 mounting plate
uchwyt U6
- U6**² cone U6 mounting plate
uchwyt U6 cone
- 1** QUARTER10 ending
zaślepka QUARTER10
- 2** QUARTER10 D ending
zaślepka QUARTER10 D
- 3** power supply cable
kabel zasilania
- 4** LED power supply
zasilacz LED

- scissors
nożyczki
- hacksaw
piłka
- pliers
kombinerki
- solder
cyna
- soldering iron
lutownica
- screwdriver
wkrętak
- drill
wiertarka

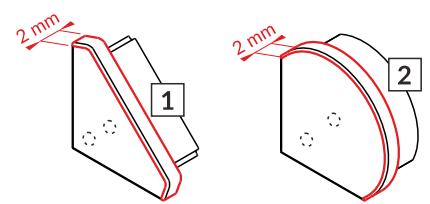
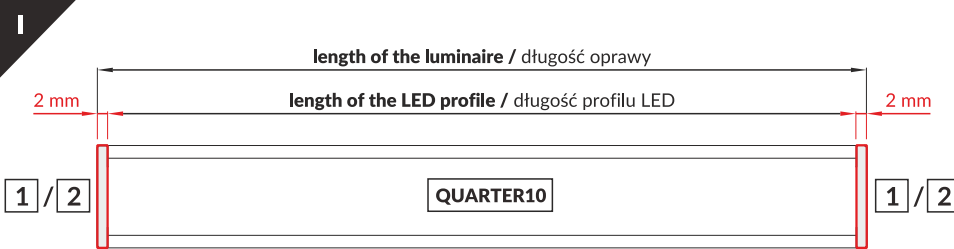

Ending with marked space to bore the holes.
Zaślepka z punktami do przewiercenia otworów.

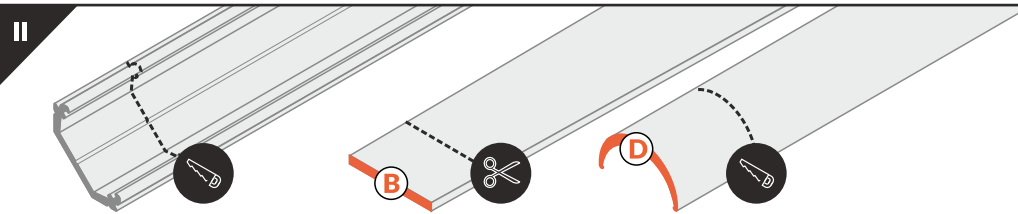

The length of the cover is equal to the length of the profile. / Długość klosza równa jest długości profilu.

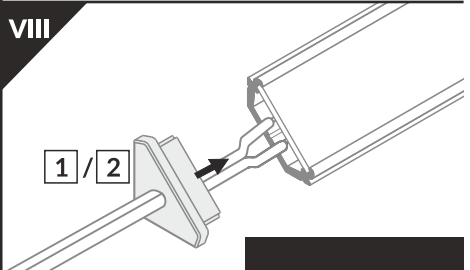
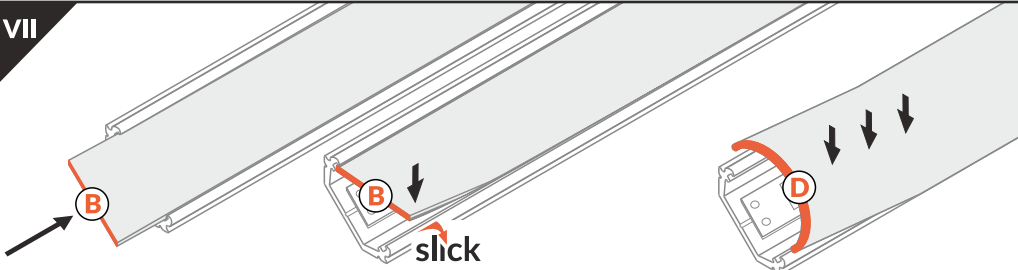
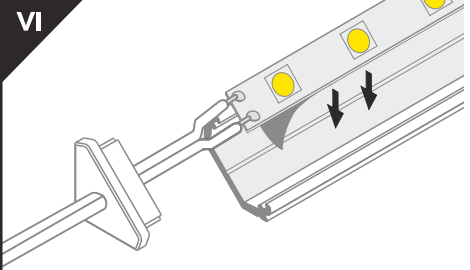
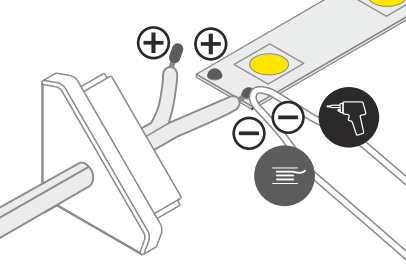
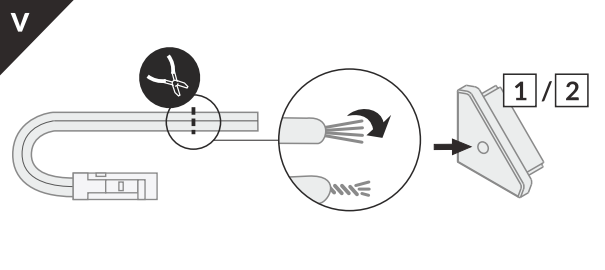
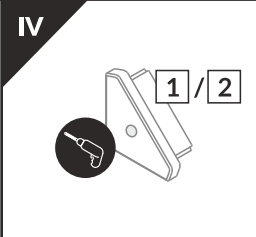
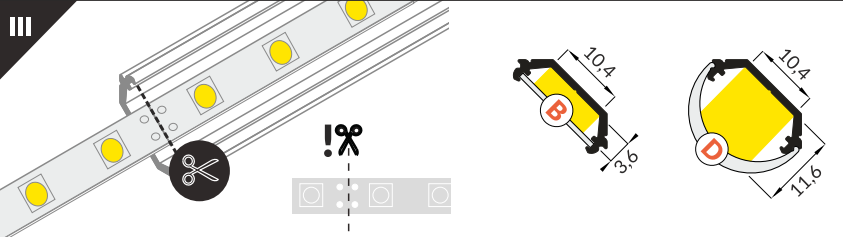

IX MOUNTING / MONTÁŽ

U6 mounting plate
uchwyt U6

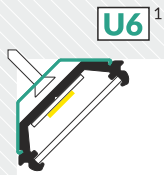

cone U6 mounting plate
uchwyt U6 cone

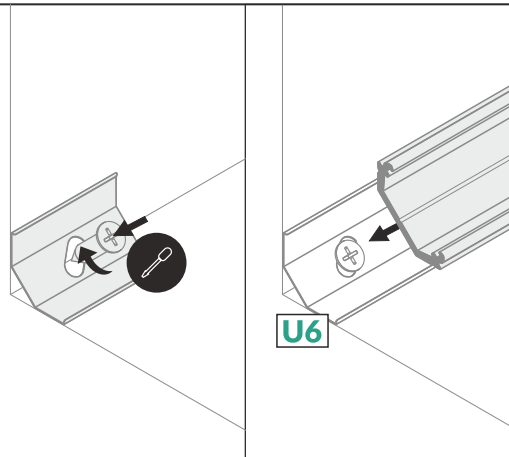
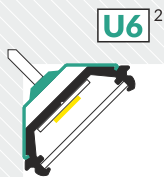

Other mounting possibilities: with mounting glue or with screws
Pozostałe możliwości montażu: na klej lub na wkręty

X POWER SUPPLY / ZASILANIE

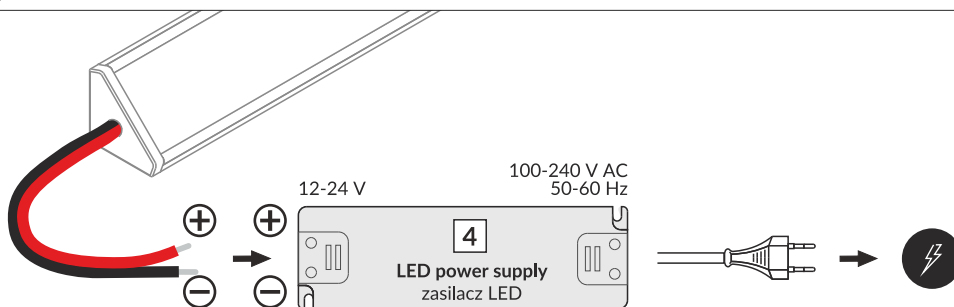

ACCESSORIES / AKCESORIA

power switches / włączniki
controller + remote / sterownik + pilot
movement sensors / czujniki ruchu

Hungarian distributor



www.s-lightled.hu | www.topmet.com

